

# NFW310M

## RF Harvester

### 1. Device Features

- Wide frequency range (500 MHz - 6 GHz)
- Input power from -10 dBm to 16 dBm
- Harvests from modulated signals
- No external components

### 2. Device Applications

- Device charging
- Wireless sensors
- Device tracking

### 3. Device Description

The NFW310M is an RF to DC converter designed to wirelessly power electronics over several meters. The harvester can be driven single-ended or differentially and generates DC power with RF inputs from -10 dBm to 16dBm without any external inductors. This part is available as bare die or bonded to a test board.

### 4. Simplified Application Diagram

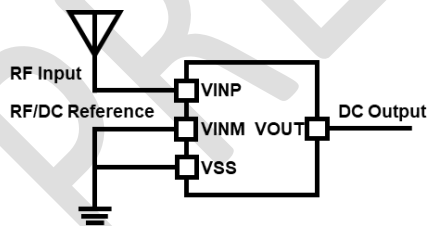

### 5. Device Pin Out (Top View)

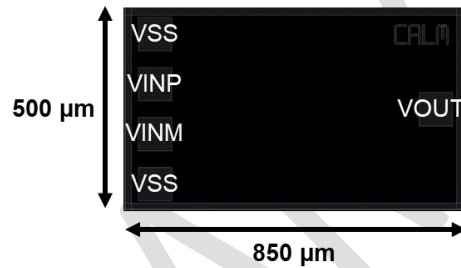

### 6. Die Photo

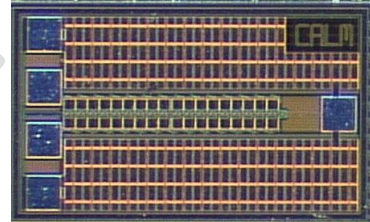

## Table of Contents

<b>1. Device Features</b> .....	<b>1</b>
<b>2. Device Applications</b> .....	<b>1</b>
<b>3. Device Description</b> .....	<b>1</b>
<b>4. Simplified Application Diagram</b> .....	<b>1</b>
<b>5. Device Pin Out (Top View)d</b> .....	<b>1</b>
<b>6. Die Photo</b> .....	<b>1</b>
<b>7. Revision History</b> .....	<b>3</b>
<b>8. Pin Configurations and Functions</b> .....	<b>4</b>
<b>9. Specifications</b> .....	<b>5</b>
9.1 Maximum Ratings .....	5
9.2 Electrical Characteristics .....	5
<b>10. Application and Implementation</b> .....	<b>6</b>
10.1 Application Schematic .....	6
10.2 Typical Characteristics .....	7
<b>11. Layout Guidelines</b> .....	<b>7</b>
<b>12. Bare Die Dimensions</b> .....	<b>8</b>
<b>Disclaimer</b> .....	<b>9</b>

## 7. Revision History

Table 1 – Revision History

Date	Version	Note
5/16/2022	0.01	Release of Draft

PRELIMINARY

## 8. Pin Configurations and Functions

Figure 1 – Device Pinout

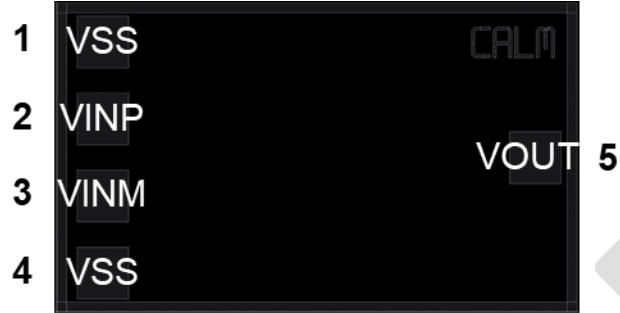

Table 2 – Pin Descriptions

PIN INFORMATION			Description
NAME	NO.	TYPE	
VSS	1	Ground	RF and DC reference voltage. Pins 1 and 4 shorted internally
VINP	2	RF Input	Positive RF input
VINM	3	RF Input	Negative RF input
VSS	4	Ground	RF and DC reference voltage. Pins 1 and 4 shorted internally
VOUT	5	DC Output	Rectifier DC output

## 9. Specifications

At T = +25°C with a 50Ω RF source impedance unless otherwise noted.

### 9.1 Maximum Ratings

Table 3 – Maximum Ratings

Parameter	Description	Min	Typ	Max	Units
PIN	RF input power			16	dBm
VOUT	DC output voltage			34	V
To	Operating temperature	-40		125	°C
Ts	Storage temperature	-40		85	°C

### 9.2 Electrical Characteristics

Table 4 – Electrical Characteristics

Parameter	Description	Conditions	Min	Typ	Max	Units
Efficiency	Peak RF to DC conversion efficiency	$R_L = 100k\Omega$ , $F_{IN} = 900MHz$ , $P_{IN} = 10dBm$			35	%
$F_{IN}$	RF input frequency		500		6000	MHz
Sensitivity	Input power to reach 1.8V out	$F_{IN} = 900MHz$ , $R_L = 10M\Omega$		-8		dBm
Sensitivity	Input power to reach 1.8V out	$F_{IN} = 2.4GHz$ , $R_L = 10M\Omega$		3		dBm
Sensitivity	Input power to reach 1.8V out	$F_{IN} = 5.8GHz$ , $R_L = 10M\Omega$		11		dBm

## 10. Application and Implementation

### Note

Information in this section is not part of NFR's device specification. Accuracy and completeness are not warranted by NFR. NFR's customers are solely responsible for determining whether the device is appropriate for their applications. Customers should characterize and verify their design and systems to confirm functionality.

### 10.1 Application Schematic

Below is a typical application schematic. The symmetrical differential inputs are interchangeable as a single RF input or can be driven with a differential source. The unused input is shorted to the VSS pins, which is connected to an AC ground to serve as the RF input and DC output reference. The NFW310M was verified with standard 50Ω antennas, cables, and connectors. Higher output voltages can be achieved with lower antenna source impedance, as conversion efficiency is improved with higher voltage swing at the RF input.

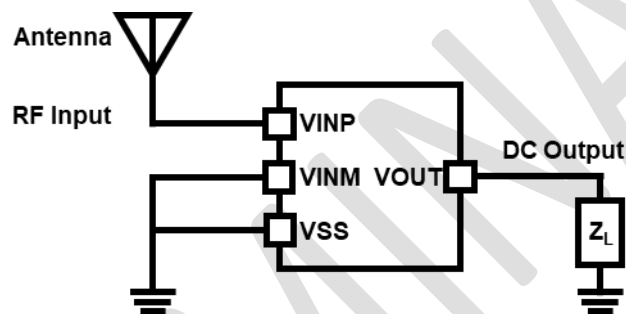
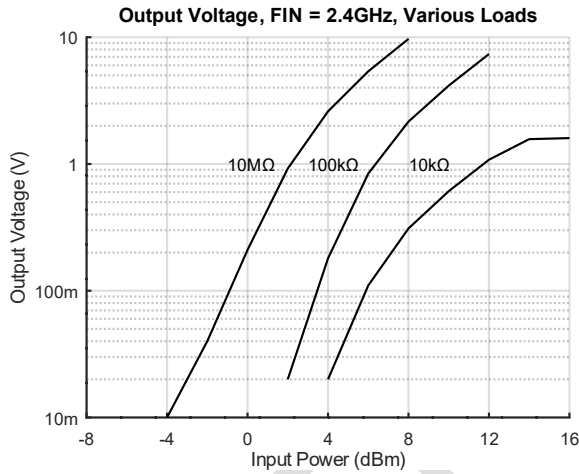
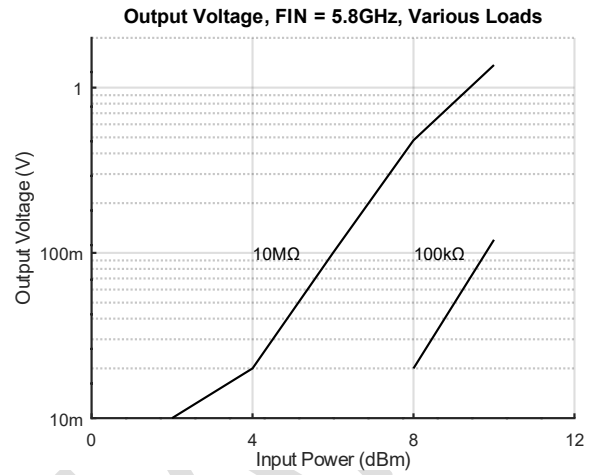
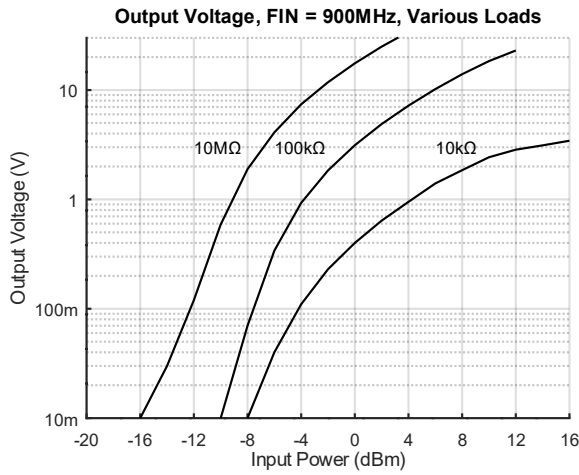

Figure 2 – Application Schematic

## 10.2 Typical Characteristics

At T = +25°C with a 50Ω RF source impedance unless otherwise noted.



## 11. Layout Guidelines

Best RF practices should be followed when laying out the PCB for the chip:

1. Input traces should impedance match the RF source
2. Sufficiently wide traces to reduce IR drops or parasitic inductive elements.

Chip will be available in both die and QFN packaged forms.

## 12. Bare Die Dimensions

The bare die is 850  $\mu\text{m}$  by 500  $\mu\text{m}$ . Pad openings are all 80  $\mu\text{m}$  by 80  $\mu\text{m}$ . Pad center locations relative to the bottom left corner of the die are given in Table 6.

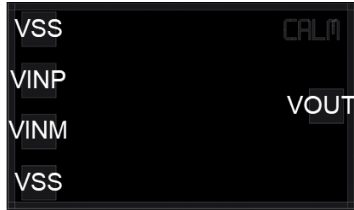

Figure 8 – Scale diagram of NFW310M. Overall dimensions are 850  $\mu\text{m}$  by 500  $\mu\text{m}$

Pin	X ( $\mu\text{m}$ )	Y ( $\mu\text{m}$ )
VSS	75	438
VINP	75	313
VINM	75	188
VSS	75	63
VOUT	779	250.5

Table 6 – Pad center locations relative to bottom left corner

PRELIMINARY



**Disclaimer**

PRELIMINARY